

Application Note: MagBlue flux gate sensors

AC and DC Residual Current Detection

Description: This document introduces flux-gate sensing techniques that can be implemented using MagBlue series products.

Version	Date	Purpose / Change description	Autor
0.1	24.05.2023	Created	N. L. Figueroa

Reproduction, publication and dissemination of this publication, enclosures hereto and the information contained therein without MAGNETEC's prior express consent is prohibited.

Disclosing the specification to third parties or using its content without written permission from MAGNETEC is strictly forbidden and every offender is liable to pay the corresponding damages.

Description

The MagBlue mounted core series are an excellent choice as the sensitive element in fluxgate sensors that can measure AC and DC residual currents at the mA level.

These sensors are at the heart of residual current devices (RCDs) that switch-off equipment when residual currents above a threshold are detected. This prevents fatal shocks, equipment damage and fires.

The fluxgate sensors in these RCDs work by measuring the response of a magnetic core: the core is periodically driven in-and-out of saturation in alternating directions. Any residual current will create a measurable offset in this behavior.

The magnetic properties of the nanocrystalline core material of the MagBlue series have been tailored for optimal sensing capabilities.

Additionally, MagBlue units come with integrated windings and inside a slit-shield that protects the core from external magnetic fields. The shielding is critical in preventing the unnecessary triggering of safety measures, that could otherwise happen from environmental noise and in-rush currents.

Many different designs and PCB-footprints are available for the MagBlue. It can be mounted in a wide array of applications, vertically or horizontally.

Features

- Fluxgate sensitive elements for sensing AC & DC currents.
- Nanocrystalline core with high permeability and temperature stability.
- Integrating windings, for sensing, testing, and calibrating.
- Slit NiFe alloy shielding suppresses external fields.
- Different casing variants and PCB footprints.

Applications

- AC/DC current sensing.
- Safety devices.

Fault current sensing in on-board chargers, wall boxes, etc.

1 | Key Specifications

All the components in the MagBlue series have the same magnetic core inside, the M-1670. The properties for this core are listed below.

Magnetic Core (M-1670)	
Parameter	Value
Outer diameter	32.2 mm (max)
Inner diameter	23.4 mm (min)
Height	7.2 mm (max)
Core material	NANOPERM®
Effective length, L_{fe}	8.71 cm
Effective cross section, A_{fe}	0.071 cm ²
Permeability (@50 Hz)	230000
AL-Value (@50 Hz, 106 mA)	15.0 μ H (min) to 28.8 μ H (max)
AL-Value (@50 Hz, 182 mA)	18.2 μ H (min) to 35.5 μ H (max)
Casing material	PA66 GF25
Fixation	Silicone-based adhesive

The cores are wound and housed in a magnetic shield, the MagBlue series have different outer dimensions/PCB footprints, but the same magnetic characteristics:

MagBlue Mounted Cores	
Parameter	Value
Wire diameter	0.14 mm
Sensing windings, N1, N2	100 turns
Sensing inductance, L1, L2 (@25°C)	175 mH (min) to 300 mH (max)
Sensing resistance, R1, R2 (@25°C)	2.2 (min) to 3.0 (max) Ω
Test winding, N3	20 turns
High voltage strength	500 V (type test)
Ambient/storage temperature	-40°C to +85°C
Magnetic Shield	50/50 NiFe alloy, 0.35 mm thick
Pin size	0.64 mm, square

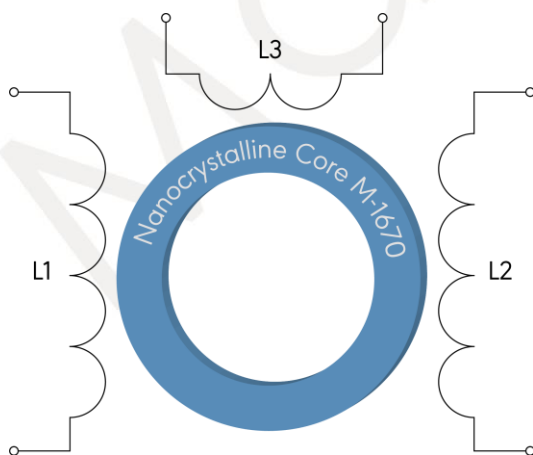

Fig. 1- Circuit schematic of the windings in the MagBlue series products. L1, L2: sensing/driving windings; L3: testing.

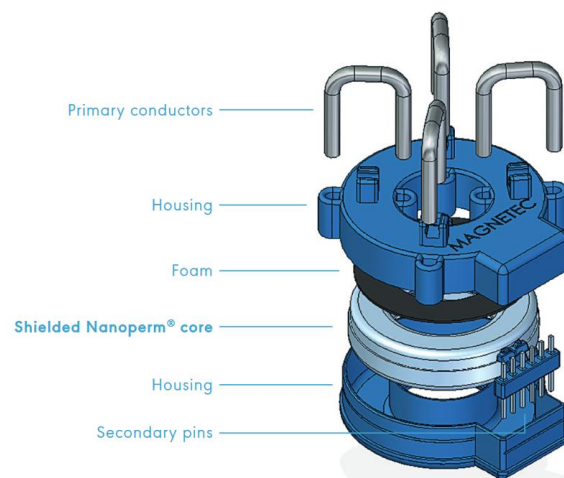

Fig. 2 Exploded view of the MagBlue sensor MB-676

2 | Working Principles

2.1 | Residual Currents

Fault currents are a hazard that can lead to fatal shocks, equipment damage and fires. These currents occur from the failure or deterioration of insulating material, which can happen in many different parts of an electrical system. A common safety measure is to monitor that the current going into the system is coming out through the intended path.

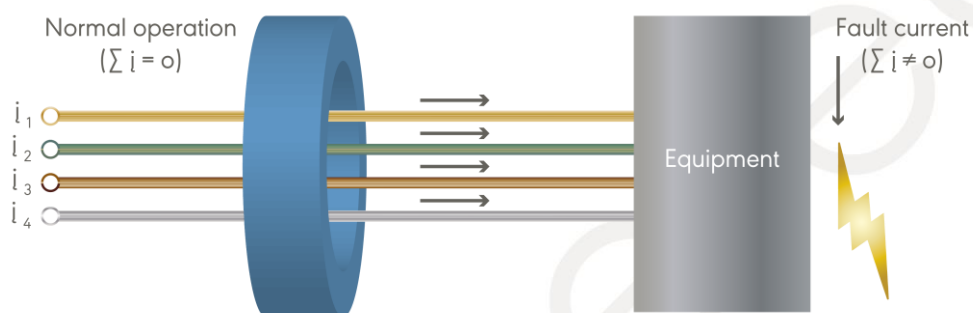

Fig. 3 Under normal conditions the total currents going in the system is zero. A fault current changes that, generating a magnetic field along the magnetic core.

This can be achieved by threading all the lines going into the equipment through a magnetic core as shown in Fig. 3. When a fault current is present, the total current going into the system is different than the current coming out, this leads to a net magnetic field going through the entire core, magnetizing it in a determined direction. This effect can be measured using the techniques outlined in Section 3.

2.2 | Magnetic Saturation

When a soft magnetic material is magnetized, microscopic magnetic moments align with the external field. As the material is magnetized it becomes harder to magnetize it further, as there are progressively less free magnetic moments. In the limit of a very strong magnetic field, all the magnetic moments are aligned, and increasing the field will not result in an increase of magnetization.

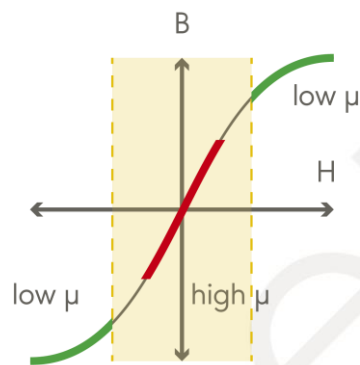

Fig. 4 B-H Curve for a magnetically soft material

This saturating behavior of magnetic materials makes inductors with saturating cores have a non-linear, current-dependent inductivity.

3 | Fluxgate sensor designs

Fluxgate sensors work by periodically driving a soft-magnetic core in-and-out of saturation in alternating directions. If there is another field, other than the one that is being applied, it will create an offset in the saturation behavior that can be measured.

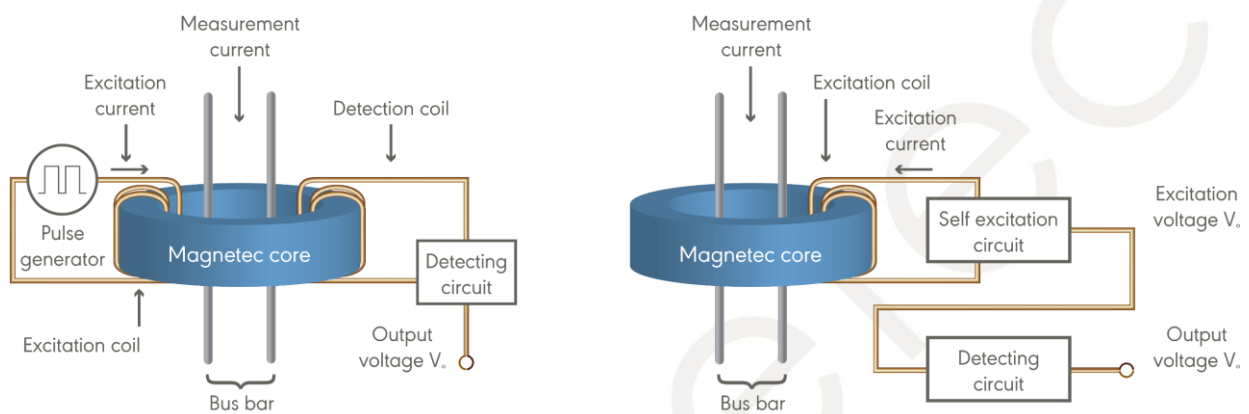

Fig. 5 Some common arrangements for fluxgate sensors.

There are many kinds of sensors that can be built using this fluxgate principle. And endless schemes: with open/closed loop configurations, with different compensation schemes, some even using several cores. Here, we lay out some of the basic principles, and present some of the most common methods fluxgate sensors operate with.

3.1 | Phase-delay fluxgate sensor

The voltage-step response of a saturable inductor is shown in Fig. 6. At the beginning there is a large inductance so the current builds up slowly. However, when the current reaches a threshold, the core becomes saturated, and its inductivity is greatly reduced. Then, the current in the inductor builds up fast, eventually reaching the DC level of V/R .

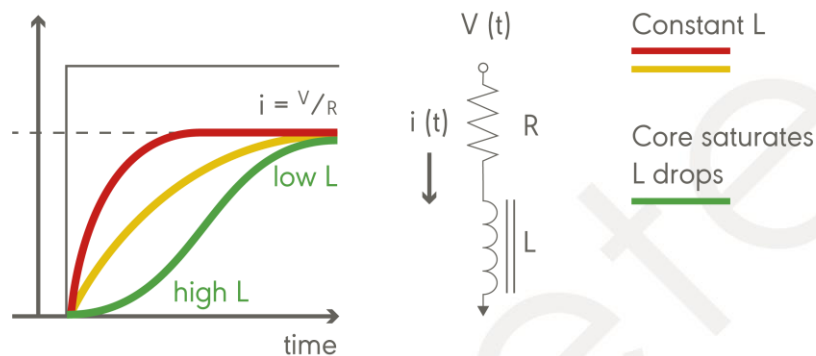

Fig. 6 The step response of a saturable core, the current builds up slowly at first because of the large inductance. At a critical current the inductance drops, and the current builds up quickly.

The time between the voltage step and the current spike depends on the external field. If the external field is working against the field generated by the current, a stronger current (and longer time) will be needed to reach saturation. If the external field is working with the field, saturation is reached sooner.

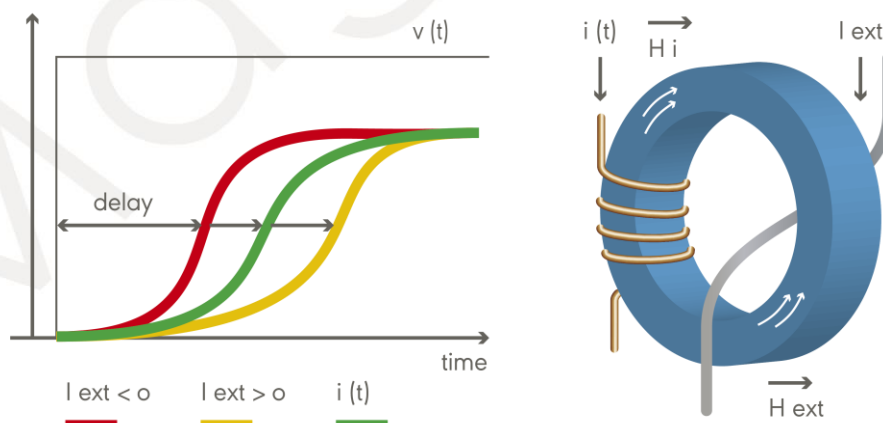

Fig. 7 The delay between the voltage step and reaching the critical current depends on the external current flowing through the core.

A simple circuit that exploits this to measure external fields/residual currents is shown below.

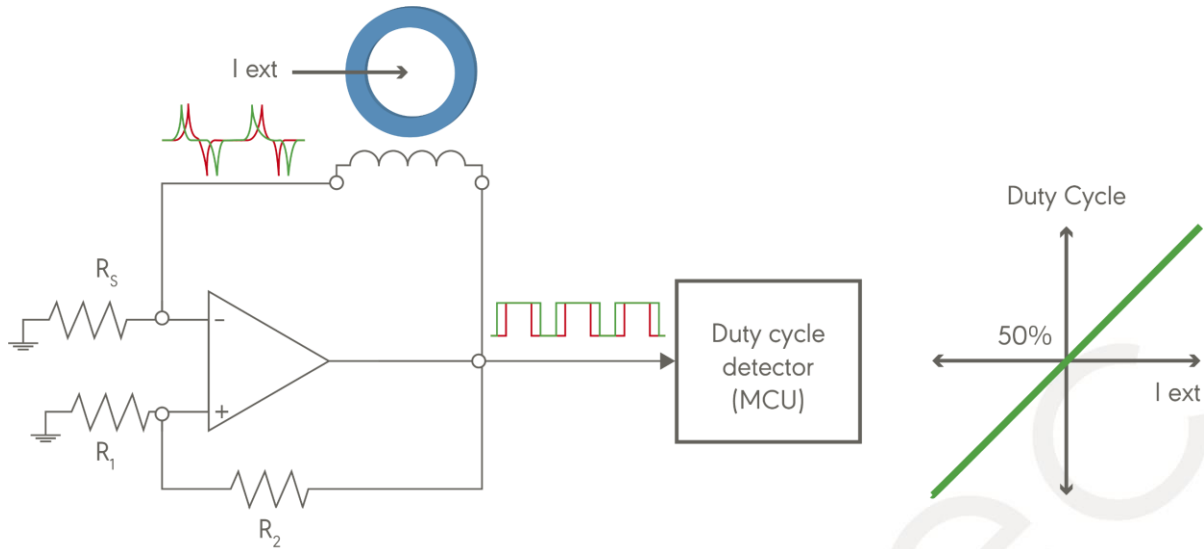

Fig. 8 Circuit diagram of a simple fluxgate sensor that can be implemented with a hysteresis comparator (Schmitt trigger). The effect of an external fault current can be seen in the waveforms drawn (green: $I_{ext} = 0$, red: $I_{ext} \neq 0$).

At the heart of the circuit is an op-amp that drives current into a core winding; the current in the core winding is sensed by the op-amp via the sensing resistor R_s . When the current increases up to a certain threshold (determined by resistances R_1 and R_2), the polarity of the output switches.

In effect, this creates an open-loop, self-oscillating fluxgate sensor. Because of the effect explained above, the delay between the polarity switch and reaching the threshold current will depend on the external magnetic field. When there is no field, (ie. the residual current is zero), the delay is the same in both directions, so there is an output duty cycle of 50%.

An external current will make the delays unbalanced, making the circuit spend more time in a determined polarity, leading to a change in the duty cycle of the output.

The PWM output of this circuit can also be changed into an analog voltage output by proper integration and filtering.

4 | Application Examples

4.1 | Usage in Wallboxes

A wallbox, in the context of electric vehicle (EV) charging applications, refers to a dedicated device installed on a wall to provide a safe and convenient charging point for electric vehicles. Wallboxes offer faster charging speeds compared to standard power outlets, and can be easily installed in homes, parking garages, workplaces, and other locations where EV charging infrastructure is required.

Wallboxes are essential for convenient and safe EV charging: they ensure the proper management of the electrical power supply and protect against potential hazards.

For this reason, the IET Wiring Regulations stateⁱ that it is required to design into all electric charging station protective measures against DC fault currents. In this context, RCDs are essential components that monitor and detect electrical imbalances in wallboxes, providing an essential layer of protection against electric shock hazards.

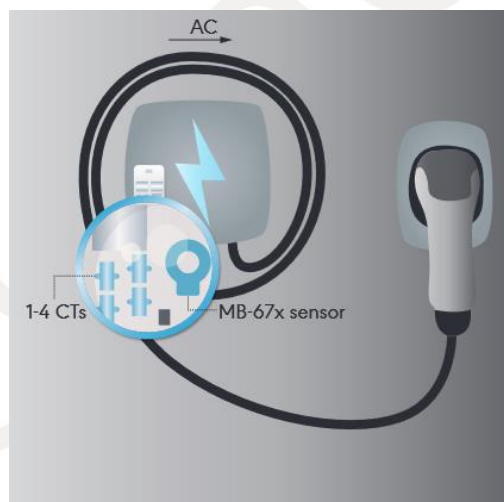

Fig. 9 RCDs with MagBlue sensors are an essential component in any wallbox to ensure safe EV charging.

ⁱ 18th Edition Section 722.531.2.101 (since 01 Jan 2019).